

mooge TECHNOLOGY

专业塑料回收设备 Recycling · Pelletizing · Shredding

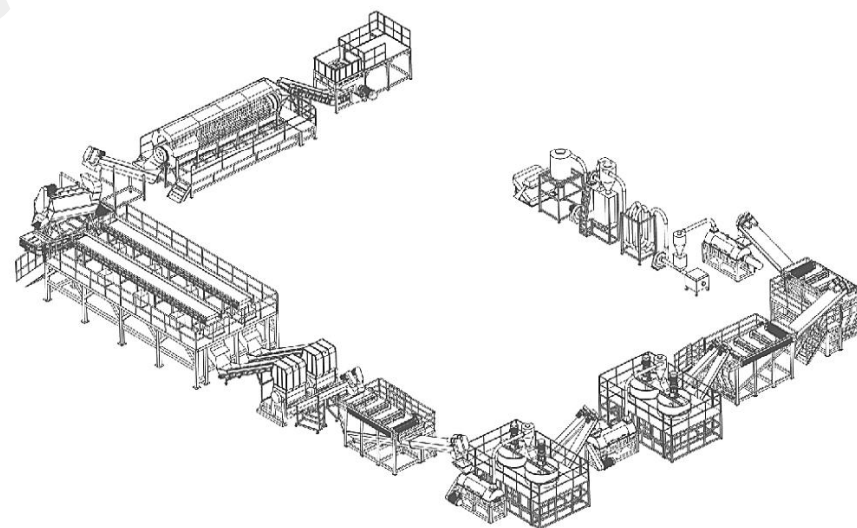

mooge
TECHNOLOGY

张家港牧格机械有限公司
ZHANGJIAGANG MOOGE MACHINERY CO., LTD.

地址：中国江苏省张家港市乐余镇永利工业区 邮编：215600
Add: A10 Jinle Road, Leyu Town, Zhangjiagang City, Jiangsu
Mobile: +86-135 8448 9215 (WhatsApp Available)
Tel: +86-512-5860 5685
Fax: +86-512-5836 1056
Web: www.moogetech.com
E-mail: sales@moogetech.com moogetech@gmail.com



张家港牧格机械有限公司
ZHANGJIAGANG MOOGE MACHINERY CO., LTD.



MOOGE TECH. 牧格机械

张家港牧格机械有限公司是一家集设计，研发，生产为一体的专业塑料机械生产制造商；公司拥有多年的塑料生产制造经验，拥有完善的加工设备和配套加工设施，生产工艺流程非常成熟；我们的塑料挤出设备和塑料回收设备，塑料粉碎机械在多年的市场使用中不断改进，通过与客户的合作沟通中不断更新，使我们变得更加专业；

公司专门从事塑料回收设备，塑料粉碎机械的生产制造；公司主要产品有塑料回收设备主要包括：PET瓶回收生产线，PE/PP薄膜回收生产线，PE/PP牛奶瓶、桶、盆回收生产线，PVC回收生产线，管材回收生产线，PE/PP回收造粒设备等；塑料粉碎机械主要包括：单轴粉碎机，双轴粉碎机，塑料粉碎机，以及其他塑料机械辅机。



ZHANGJIAGANG MOOGE MACHINERY CO., LTD is a Professional Plastic Machinery manufacturer company located in Zhangjiagang city, Jiangsu Province of China; We are dedicated to designing and developing the high technology Plastic Machinery. We have more than 10 years experience in the Plastic Machinery manufacturing. We have full processing equipment and the processing facilities such as the metal shearing machine, metal bending machine, lather machine, milling machine and so on; Our main products is the Plastic Extrusion Machinery, Plastic Recycling Machinery, Plastic Shredding Machinery, Plastic Auxiliary Machinery; Our machinery successful passed many years working by our customers. We are always keeping improvement our products by the feedback and tracking service from our customers which makes our products better and better;

Our Plastic Extrusion Machinery mainly include the Plastic sheet/board Extrusion line, PVC coil mat production line, Free foam board Production line, PVC Pipe Extrusion line, HDPE Pipe Extrusion line, Corrugated Pipe Extrusion line; The Plastic Recycling Machinery mainly include the PET Bottle Washing Recycling line, PE/PP Film Washing Recycling line, HDPE milk Bottle Washing Recycling Line, Rigid PP/PP bucket, drum, container Washing Recycling line, PVC Recycling line, HDPE Pipe Recycling Line, PE/PP Film Pelletizing line, PE/PP Rigid plastic Pelletizing line, PET Pelletizing line; The Plastic Shredding machinery mainly include the Single shaft Shredder machinery, Double Shaft Shredder machinery, Plastic Crusher, Plastic Granulator machine, PET Bottle Shredder machine; The Auxiliary machinery mainly include the Plastic Crusher, Screw Loader, vacuum loader, powder loader, High speed mixing machinery, cooling mixer machine, Color mixer machine, Hopper Dryer machine, water Chiller machine Plastic Baler machine and so on;



公司一直秉承质量第一，服务至上的发展理念，不断创造更新生产技术和工艺；我们追求卓越不断提升自身实力，我们精益求精为客户提供更加全面，高效的解决方案；愿广大客户，朋友加入我们牧格机械，能和您携手共同成长为您提供实现美好梦想的机会是我们不懈的追求！

精益求精，牧格机械真诚期待与您合作！

Our developing concept is Quality First, Service First, Customer First, Enterprise staff First; We are continuous creating and updating our technology and designing; We pursue excellence and constantly improve our ability and keep providing our customer more comprehensive and efficient solutions; We are appreciate if you can join us to working together and developing together and growing up together;

Looking forward to cooperating with you for a better tomorrow with you its our unremitting pursuit!

Your Sincerely, ZHANGJIAGANG MOOGE MACHINERY Co., Ltd

PET

Recycling Machine

聚酯回收设备

500kg/hr
Standard Type



MT-500 PET Bottle Recycling Machine

MT-500 PET瓶回收生产线 (标准型)

该设备主要用来回收废旧的塑料PET瓶，矿泉水瓶，饮料瓶，PET片材，PET包装盒以及其他PET材料；PET瓶回收生产线主要包括输送机，开包机，脱标机(干脱标机或者带水脱标机)，分选系统(可人工分选也可以配备自动化分选设备)，金属探测系统，破碎(粉碎)机，漂洗槽，热清洗机，摩擦清洗设备，后道漂洗槽，脱水机，干燥系统，标签分离系统，以及包装设备；通过以上一系列的能有效去除瓶子表面的标签，除掉瓶盖，瓶环，胶水，泥沙等杂质，最终得到干净的瓶片。可以根据客户不同要求，最终产品要求设计生产不同的配置的生产线。

This PET Recycling Machine is mainly used to recycling the waste PET bottles, water bottles, cola bottles and PET sheet, PET packing containers;
It include the: Conveyor Belt, Label Remover(dry type or water type), sorting system(can be manually or automatically sorting system), metal detecting system, Plastic Crusher Machine(Plastic Grinder), Floating washing tank, Hot washing tank, Friction washing, after floating washing tank, dewatering machine, hot air drying system, label/dust/fin separator and packing system; With the above machines can easily to remove the labels, caps, rings, glue, dirties and other impurities, finally you will produce to clean PET flakes;
We can customize make the line according to your requirement.

Estimate Plant Requirement

Model 型号	Capacity 产量	Installed Power 装机功率	Steam Use 蒸汽	Water Supply 供水	Area Required: L*W*H 尺寸: 长*宽*高
MT-500	500kg/hr	125KW+60KW	Optional	4-5m³/hr	55m × 3.5m × 4.5m



Optional Choose:
Label Remover (Water Type)

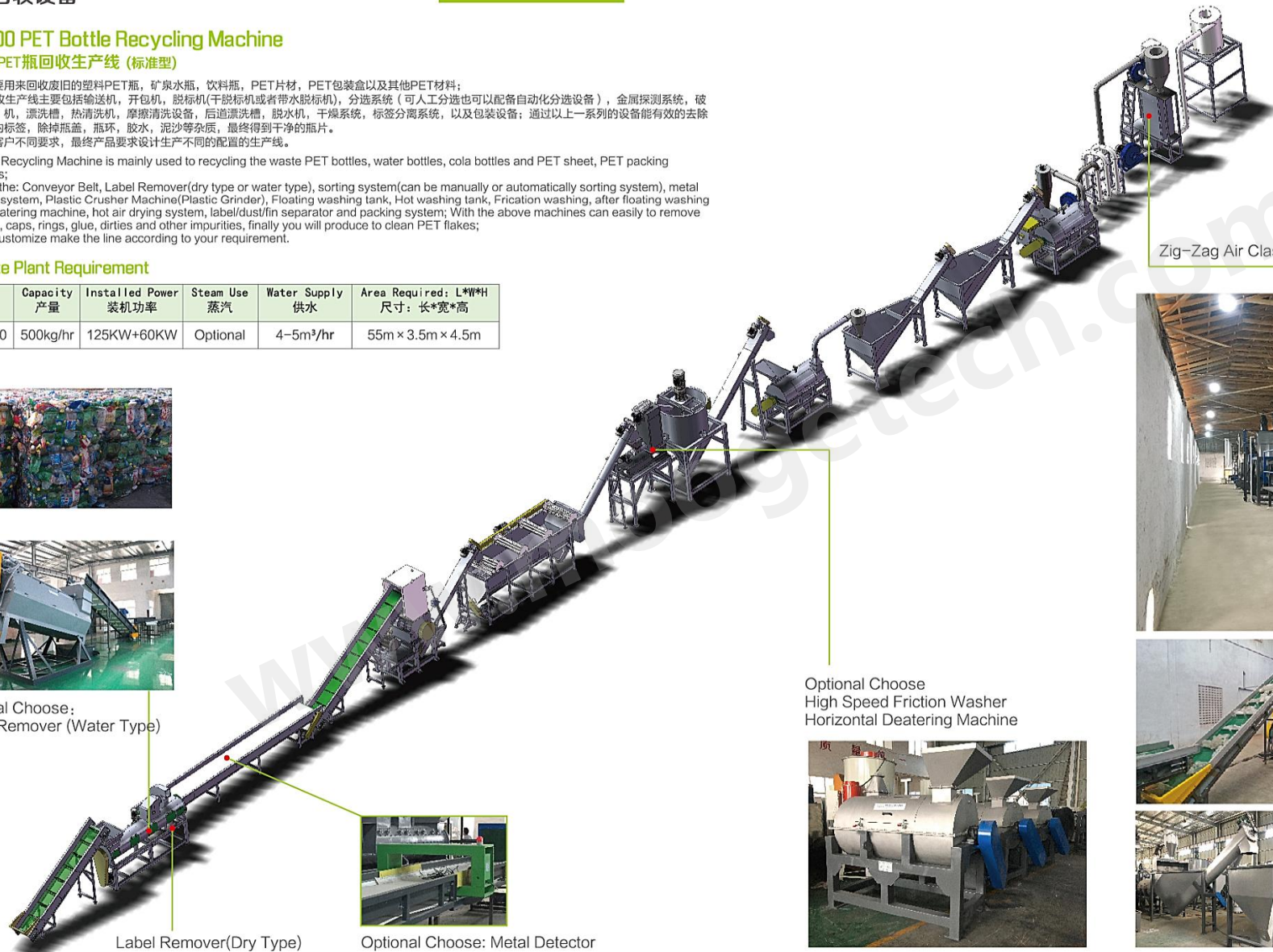

Label Remover(Dry Type)



Optional Choose: Metal Detector

Optional Choose
High Speed Friction Washer
Horizontal Deatering Machine



Zig-Zag Air Classifier

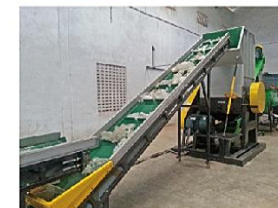

PET

Recycling Machine

聚酯回收设备

1000kg/hr
Economic Type



MT-1000 PET Bottle Recycling Machine

MT-1000 PET瓶回收生产线 (经济型)

该系列产品专门为化纤生产量身打造，产品可以用来生产2-D、3-D 化纤或者用来拉丝，做PET打包带，包装片材，薄膜等；可以配置工业电脑PLC全自动控制，能有效降低能耗以及控制最终产品质量；可以配备进口自动材质分选以及颜色分选设备；我们也可以根据客户实际物料的干净程度来配置不同的生产线；

This series PET Recycling machine is specially designed to produce fiber use PET flakes; The flakes can be used for the 2-D, 3-D PSF, filament yarn, PET strap, PET sheet or PET film; The machine can adopt the PLC automatic control the full line to control the final products quality and save energy; It can be equipped with the Europe automatic material sorting system and color sorting system; We also can configure the line according to the raw material and customer requirement.

Estimate Plant Requirement

Model 型号	Capacity 产量	Installed Power 装机功率	Steam Use 蒸汽	Water Supply 供水	ManPower 人工	Area Required: L*W*H 尺寸: 长*宽*高
MT-1000E	1000kg/hr	185KW+120KW	Optional	5-6m³/hr	7-8 Person	55m × 6m × 3.5m



Optional Choose:
Zig-Zag Air Classifier

Optional Choose
High Speed Friction Washer
Horizontal Deatering Machine



Optional Choose:
Bale Opener Machine



Optional Choose:
Trommel Machine



Optional Choose:
Metal Detector



Optional Choose:
Steam Boiler System

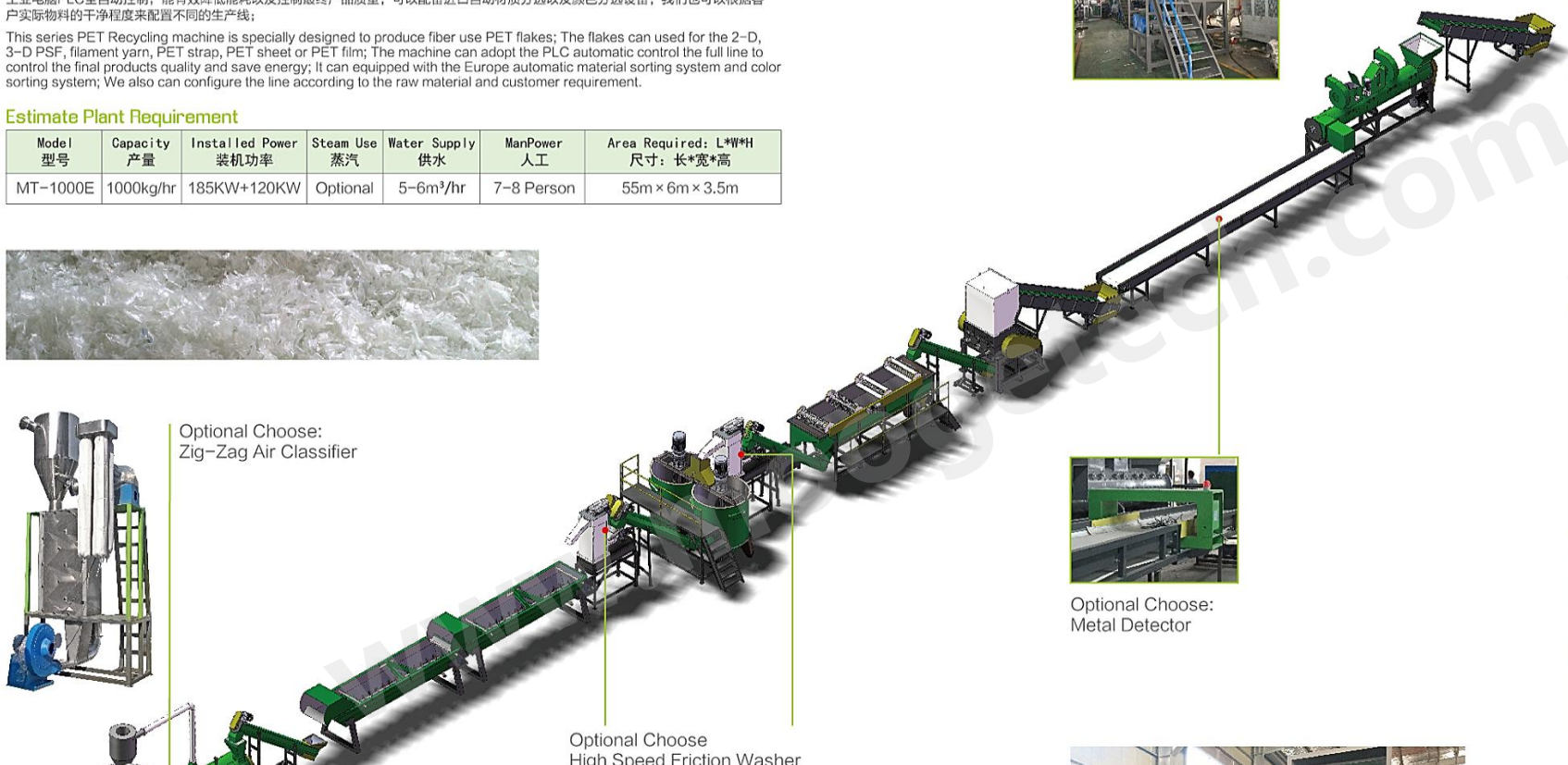

PET Recycling Machine

聚酯回收设备

1000kg/hr
Classic Type

MT-1000 PET Bottle Recycling Machine

MT-1000 PET瓶回收生产线 (经典型)

该系列产品专门为化纤生产量身打造，产品可以用来生产2-D、3-D 化纤或者用来拉丝，做PET打包带，包装片材，薄膜等；可以配置工业电脑PLC全自动控制，能有效降低能耗以及控制最终产品质量；可以配备进口自动材质分选以及颜色分选设备；我们也可以根据客户实际物料的干净程度来配置不同的生产线；

This series PET Recycling machine is specially designed to produce fiber use PET flakes; The flakes can be used for the 2-D, 3-D PSF, filament yarn, PET strap, PET sheet or PET film; The machine can adopt the PLC automatic control the full line to control the final products quality and save energy; It can be equipped with the Europe automatic material sorting system and color sorting system; We also can configure the line according to the raw material and customer requirement.

Estimate Plant Requirement

Model 型号	Capacity 产量	Installed Power 装机功率	Steam Use 蒸汽	Water Supply 供水	ManPower 人工	Area Required: L*W*H 尺寸: 长*宽*高
MT-1000C	1000kg/hr	200KW+120KW	Optional	5-6m³/hr	7-8 Person	62m × 5m × 4.5m



Optional Choose:
Full Automatic Metal Detector



Optional Choose:
Label Remover (Water Type)

Optional Choose:
Bale Opener Machine



Optional Choose:
Trommel Machine



Optional Choose:
Double Station Penumatic Silo

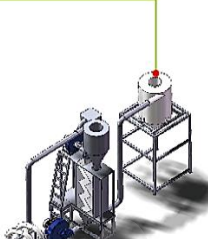

Optional Choose: Steam Boiler System



PET

Recycling Machine

聚酯回收设备

2000kg/hr
Classic Type



MT-2000 PET Bottle Recycling Machine

MT-2000 PET瓶回收生产线 (经典型)

该系列产品专门为化纤生产量身打造，产品可以用来生产2-D、3-D 化纤或者用来拉丝，做PET打包带，包装片材，薄膜等；可以配置工业电脑PLC全自动控制，能有效降低能耗以及控制最终产品质量；可以配备进口自动材质分选以及颜色分选设备；我们也可以根据客户实际物料的干净程度来配置不同的生产线；

This series PET Recycling machine is specially designed to produce fiber use PET flakes; The flakes can be used for the 2-D, 3-D PSF, filament yarn, PET strap, PET sheet or PET film; The machine can adopt the PLC automatic control the full line to control the final products quality and save energy; It can be equipped with the Europe automatic material sorting system and color sorting system; We also can configure the line according to the raw material and customer requirement.

Estimate Plant Requirement

Model 型号	Capacity 产量	Installed Power 装机功率	Steam Use 蒸汽	Water Supply 供水	ManPower 人工	Area Required: L*W*H 尺寸: 长*宽*高
MT-2000	2000kg/hr	325KW+120KW	Suggest use	10-15m³/hr	10-12 Person	80m × 6m × 5m



Optional Choose:
Label Remover (Water Type)



Optional Choose:
Full Automatic Metal Detector

Optional Choose:
Bale Opener Machine



Optional Choose:
Trommel Machine

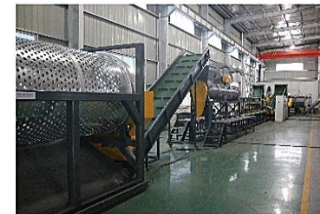
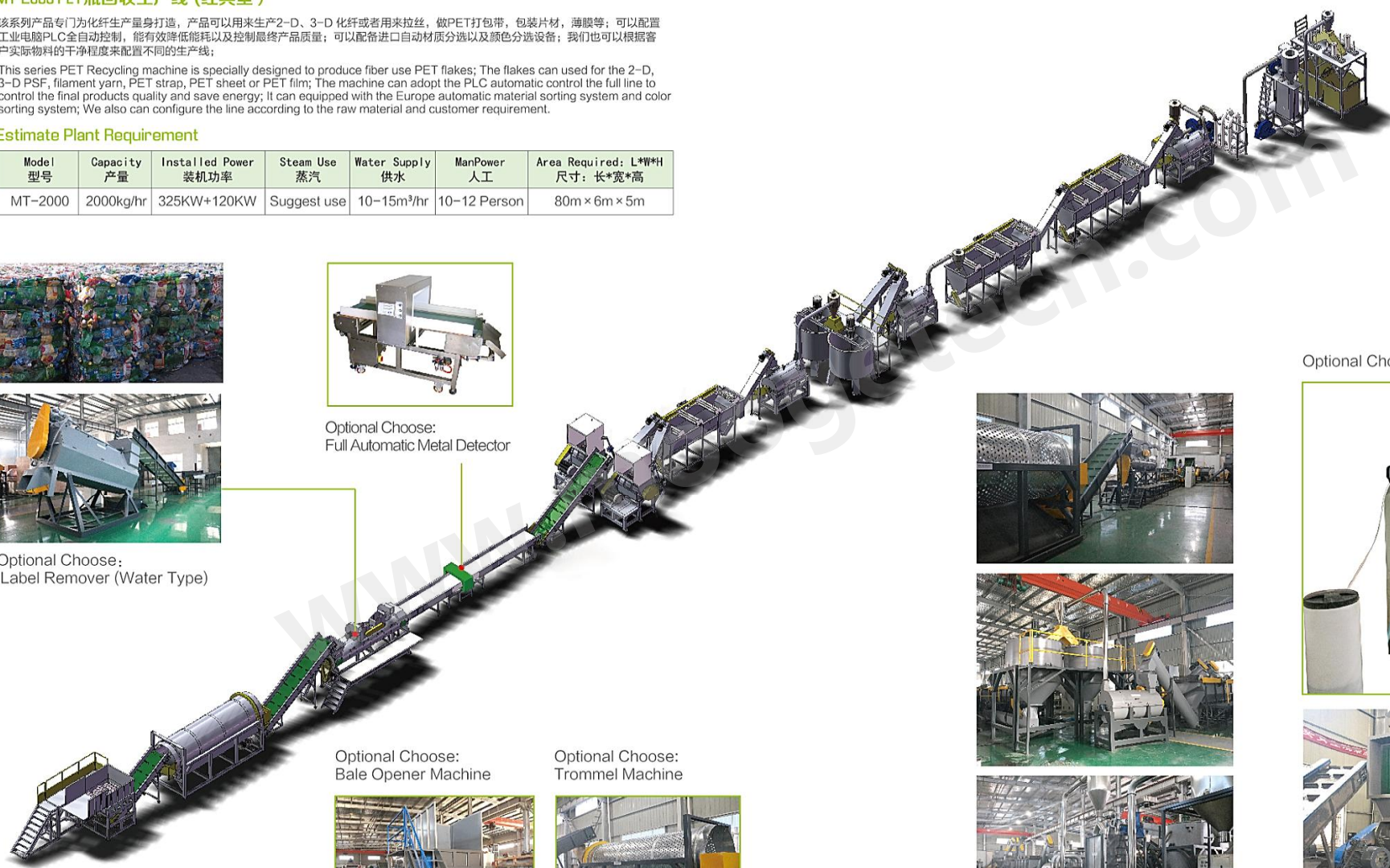

Optional Choose: Steam Boiler System



PET

Recycling Machine

聚酯回收设备

3000kg/hr
Classic Type



MT-3000 PET Bottle Recycling Machine

MT-3000PET瓶回收生产线 (经典型)

该系列产品专门为化纤生产量身打造，产品可以用来生产2-D、3-D 化纤或者用来拉丝，做PET打包带，包装片材，薄膜等；可以配置工业电脑PLC全自动控制，能有效降低能耗以及控制最终产品质量；可以配备进口自动材质分选以及颜色分选设备；我们也可以根据客户实际物料的干净程度来配置不同的生产线；

This series PET Recycling machine is specially designed to produce fiber use PET flakes; The flakes can be used for the 2-D, 3-D PSF, filament yarn, PET strap, PET sheet or PET film; The machine can adopt the PLC automatic control the full line to control the final products quality and save energy; It can be equipped with the Europe automatic material sorting system and color sorting system; We also can configure the line according to the raw material and customer requirement.

Estimate Plant Requirement

Model 型号	Capacity 产量	Installed Power 装机功率	Steam Use 蒸汽	Water Supply 供水	ManPower 人工	Area Required: L*W*H 尺寸: 长*宽*高
MT-3000	3000kg/hr	600KW	Suggest use	20-30m³/hr	12-15 Person	100m × 8m × 5.5m

Optional Choose:
Steam Boiler System



Optional Choose:
Double Station Penumatic Silo



PET

Recycling Machine

聚酯回收设备

3000~5000kg/hr
Classic Type



MT-3000~5000 PET Bottle Recycling Machine

MT-3000~5000 PET瓶回收生产线 (经典型)

本生产线采用高度自动化电脑PLC控制，尽量减少认为操作失误；采用高效清洗系统以及成品检测系统能有效的生产出高质量的瓶片；可配备自动材质分选设备以及颜色分选设备，可以减少人工以及提供产品质量；我们也可以根据客户实际情况，物料干净程度来配备不同配置的生产线来达到客户需求；

The MT-3000 PET bottle washing line is primarily as a first part of food grade PET bottle recycling project. Its high automation will maximally avoid human caused errors. In addition, with efficient blending and inspection systems, the quality of PET flakes ensures stable reprocessing. Can equipped with automatic plastic sorting machine and color sorting machine will save manpower and improve production efficiency and thus bring actual highly automated production. The line can configured with flexible technological process and machinery composition according to differences of actual raw material condition to meet the practical requirements of different customers.

Estimate Plant Requirement

Model 型号	Capacity 产量	Installed Power 装机功率	Steam Use 蒸汽	Water Supply 供水	ManPower 人工	Area Required: L*W*H 尺寸: 长*宽*高
MT-3000	3000kg/hr	600KW	80000Kcal	20~30m³/hr	12~15 Person	100m × 8m × 5.5m
MT-4000	4000kg/hr	800KW	100000Kcal	30~40m³/hr	15~20 Person	135m × 8m × 6.5m
MT-5000	5000kg/hr	1000KW	120000Kcal	40~50m³/hr	15~20Person	135m × 8m × 6.5m



Optional Choose:
Double Station Penumatic Silo



Sample Projects 工程案例



MT-500 PET Washing Line in Poland

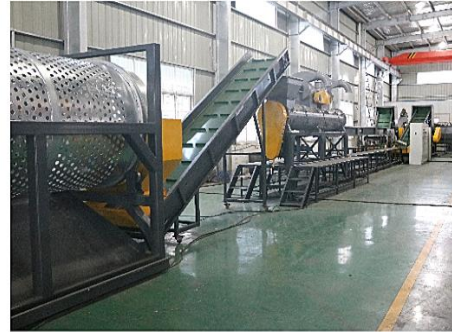

MT-1000 PET Washing Line in Yemen



ME-300 PE/PP Washing Line in Russia



ME-1000 PE/PP Washing Line in Brasil



MT-1000 PET Washing Line in South Africa



MT-2000 PET Washing Line in Algeria



MEB-300 Rigid PE/PP Washing Line in Mexico



RDS-SJ85 Film Pelletizing Line In Lebanon



MT-2000 PET Washing Line in Mexico



MT-3000 PET Washing Line in Ganzhou/China



RSS-SJ130 Film Pelletizing Line in Holand



PSF-SJ160 PSF Pelletizing Line in Pakistan

PE/PP (Soft Form)

Film, Raffia/Woven Bags, Jumbo Bags Recycling Machine

薄膜, 编织袋, 吨包袋回收设备

www.moogetech.com



ME- Series PE/PP Film, Raffia/Woven Bags, Jumbo Bags Recycling Machine ME- 系列 PE/PP 薄膜, 编织袋, 吨包袋回收设备

主要用于废旧 PE/PP 薄膜, 编织袋 破碎, 清洗, 回收; 整条生产线包括物料输送, 金属检测 (选配), 破碎粉碎 (带水), 漂洗, 高速摩擦清洗, 离心脱水, 干燥, 物料收集包装等系统;
我公司具有专门为薄膜破碎而研制的薄膜破碎机, 粉碎机能有有效的将薄膜粉碎, 提高产量, 粉出的薄膜尺寸细小, 有利于后面的清洗干净; 产量高能节约人工河能耗; 同时可配备废旧薄膜打包机, 薄膜包块剪切机, 滚筒筛分系统 (能有效将薄膜内部的泥沙, 石块筛分出来, 保护后面粉碎刀片不受损伤)。

Standard System

Estimate Plant Requirement

Model 型号	Capacity 产量	Installed Power 装机功率	Water Supply 供水	ManPower 人工	Area Required: L*W*H 尺寸: 长*宽*高
ME-300	300kg/hr	150KW	4-5m³/hr	1-2	24m × 4m × 5m
ME-500	500kg/hr	225KW	6-8m³/hr	1-2	25m × 4m × 5m



It used to recycling the waste PE/PP film and sack. The production line including the conveyor belt, metal detector(Optional), Wet crusher, material floating, high speed friction washing, centrifuge dewatering machine, drying system and material collecting.
We have special crusher, grinder machine for the film, sack, with special blades design and the mesh design; so the output material is smaller size but capacity is higher; It will help the washing the material more cleaning; And save labor cost and save energy;
You also can choose use the shredder machine to reduction the material size, its according to your requirement;
if use the shredder, the blades will lasting longer time and save blades changing labor cost;
This production line can come with the plastic baler machine, to produce the plastic bale easy for transportation.
Also we have the hydraulic bale cutting machine, it can shearing the bale into smaller pieces. After the shearing we have the trommel machine use to screening out the inside sand, rocks from the material;

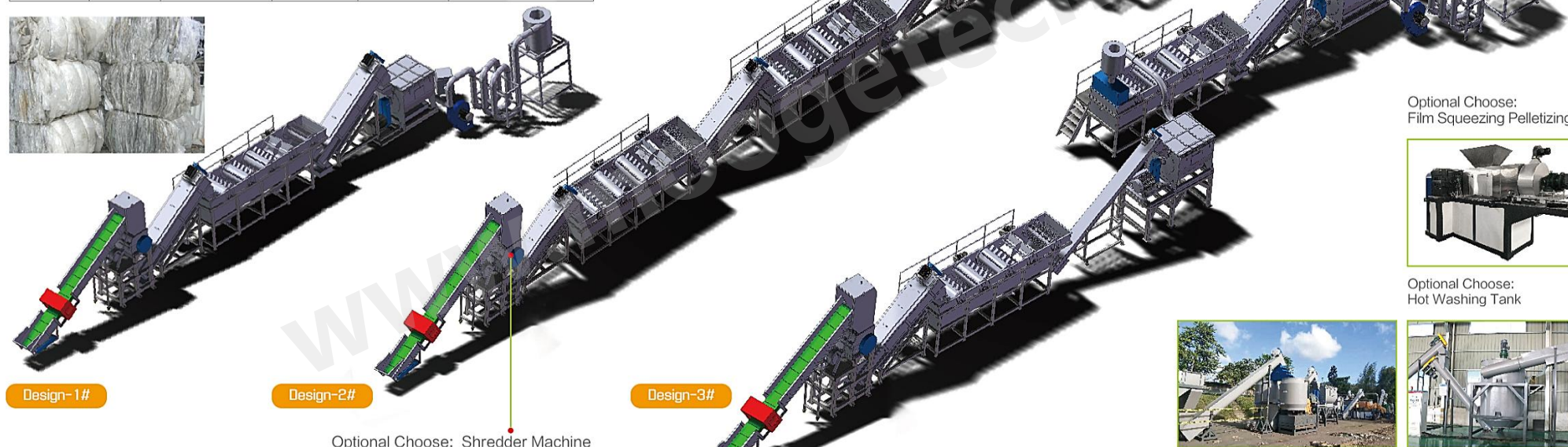

Design-1#

Design-2#

Design-3#

Optional Choose:
Film Squeezing Pelletizing Machine



Optional Choose:
Hot Washing Tank



Optional Choose: Shredder Machine



Inside



Advanced System

Estimate Plant Requirement

Model 型号	Capacity 产量	Installed Power 装机功率	Hot Washing 热清洗	Water Supply 供水	ManPower 人工	Area Required: L*W*H 尺寸: 长*宽*高
ME-300	300kg/hr	200KW	Optional	6-8m³/hr	1-2	40m × 4m × 5m
ME-500	500kg/hr	350KW	Optional	8-10m³/hr	1-2	40m × 4m × 5m
ME-1000	1000kg/hr	600KW	Optional	15-20m³/hr	2-3	55m × 6m × 6m



PE/PP/ABS/PS (Rigid Form)

Bottle, Bucket, Hollow Container Recycling Machine

瓶, 壶, 桶回收设备



MEB- Series PE/PP/ABS/PS Bottle, Bucket, Hollow Container Recycling Machine

MEB-系列 PE/PP/ABS/PS 瓶, 桶回收设备

主要用于废旧 PE/PP/ABS/PS 牛奶瓶, 盆, 等容器的破碎, 清洗, 回收; 整条生产线包括物料输送, 金属检测, 破碎粉碎 (可带水), 漂洗, 高速摩擦清洗, 离心脱水, 干燥, 物料收集包装等系统;

It used to recycling the waste PE/PP/ABS/PS bottles and buckets, hollow containers and so on. The production line including the conveyor belt, metal detector, Plastic Wet crusher, floating washing tank, high speed friction washer, centrifuge dewatering machine, drying system and label separating machine, material collecting packing system.

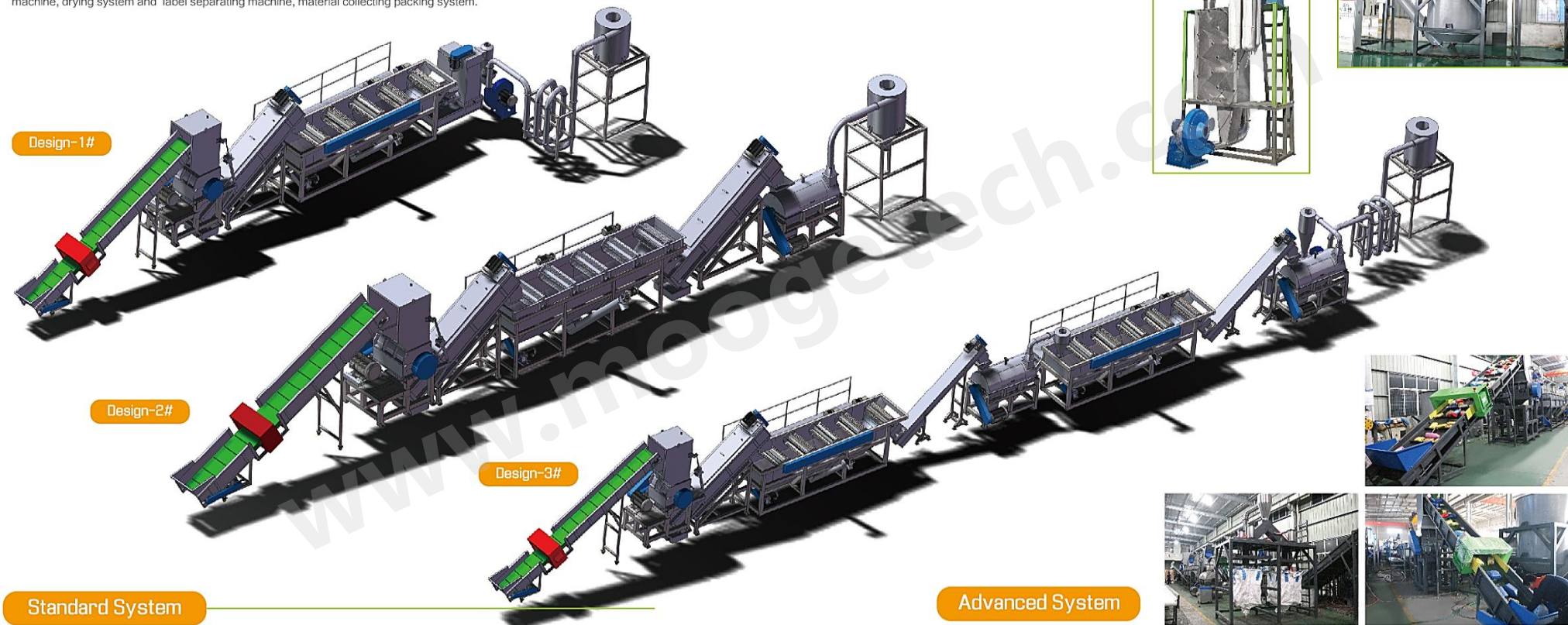

Optional Choose:
Zig-Zag Air Classifier



Optional Choose: Hot Washing Tank



Standard System

Estimate Plant Requirement

Model 型号	Capacity 产量	Installed Power 装机功率	Hot Washing 热清洗	Water Supply 供水	ManPower 人工	Area Required: L*W*H 尺寸: 长*宽*高
MEB-300	300kg/hr	100KW	Optional	4-5m ³ /hr	1-2	20m × 4.5m × 5m
MEB-500	500kg/hr	115KW	Optional	5-6m ³ /hr	1-2	20m × 4.5m × 5m
MEB-1000	1000kg/hr	125KW	Optional	7-8m ³ /hr	2-3	23m × 5m × 5m
MEB-1500	1500kg/hr	180KW	Optional	8-10m ³ /hr	2-3	25m × 5m × 5m
MEB-2000	2000kg/hr	225KW	Optional	10-15m ³ /hr	2-3	28m × 5m × 5m

Advanced System

Estimate Plant Requirement

Model 型号	Capacity 产量	Installed Power 装机功率	Hot Washing 热清洗	Water Supply 供水	ManPower 人工	Area Required: L*W*H 尺寸: 长*宽*高
MEB-300	300kg/hr	130KW	Optional	5-6m ³ /hr	1-2	38m × 4.5m × 5m
MEB-500	500kg/hr	145KW	Optional	7-8m ³ /hr	1-2	38m × 4.5m × 5m
MEB-1000	1000kg/hr	190KW	Optional	8-10m ³ /hr	2-3	42m × 5m × 5m
MEB-1500	1500kg/hr	230KW	Optional	10-15m ³ /hr	2-3	45m × 5m × 5m
MEB-2000	2000kg/hr	280KW	Optional	15-20m ³ /hr	2-3	45m × 5m × 5m

PLASTIC

Recycling Machinery
回收机械

www.moogetech.com



拆包机
De-Baler Machine



滚筒分离机
Trommel Machine



液压剪切机
Hydraulic Guillotine Machine



薄膜脱水机
Film Centrifugal Machine



干式脱标机
Dry Type Label Remover



带水脱标机
Water Type Label Remover



高速摩擦清洗机
High Speed Friction Washer



立式脱水机
Vertical Flakes Centrifugal Machine



星型筛分机
Star Screen Machine



瓶片脱水机
Flakes Centrifugal Machine



塑料瓶打孔机
Plastic Bottle Perforator Machine

该设备主要用于塑料瓶打孔，有效排出瓶内气体和液体，减少压缩体积，便于运输

The Bottle Perforator is designed to perforate plastic bottles (PET and HDPE, ETC) before these materials go into the baler. After perforation, these plastics can be compacted effectively into bales that are more homogeneous, dense and heavier. The perforated bottles protect bales from the risk of wires snapping due to rising pressure caused by the air bubbles left behind in the compacted material. With the Bottle Perforator, the air can now escape through the perforation holes. During the compacting of non-perforated bottles, many still containing their caps, isolated air bubbles remain in the bale. When the temperature rises due to exposure to the sun, the pressure increases and then the wire ties around the bale may snap.



Compactor/Agglomerator Machine 团粒机

GHX系列主要用于生产PET等化纤类材料
GHX-Series For the PET Fiber to produce the POP-Corn material

型号/Model	GHX-100	GHX-300	GHX-400	GHX-500
容积/Volume:L	100	300	400	500
有效容积/Effective Volume: L	75	225	340	375
生产能力/Capacity: kg/h	200	350	500	700
电机功率/Motor: kW	45	90	110	160



GSL系列主要用于生产PE、PP等塑料薄膜类
GSL-Series For the PE/PP Film, Woven Bags, Non-woven Plastic

型号/Model	GSL-100	GSL-200	GSL-300	GSL-500	GSL-600	GSL-800	GSL-1500
容积/Volume:L	100	200	300	500	600	800	1500
有效容积/Effective Volume: L	75	150	225	375	450	600	1000
生产能力/Capacity: kg/h	60-100	100-150	150-250	300-400	350-450	500-600	900-1200
电机功率/Motor: kW	37	55	75	90	110	132	185

Film squeezing machine 薄膜挤干机

FS系列主要用于去除清洗后的薄膜，编织袋等不同软料的水分
FS-Series Used for remove the water from washed plastic(film,bag,woven bag,jumbo bag)scrap



型号/model	FS-300	FS-500	FS-1000
产量/Capacity (kg/hr)	300	500	800-1000
螺杆直径/Screw Diameter (mm)	Φ250	Φ325	Φ380
螺杆长度/Screw Length (mm)	1550	1550	1550
主机功率/Main motor power (KW)	30	45	55
液压站功率/Hydraulic power (KW)	1.5	1.5	1.5
含水率/moisture remain	5-8%	5-8%	5-8%

Film squeezing pelletizing machine 挤干造粒机

本设备主要用于干燥清洗后的薄膜，编织袋等不同软料并且塑化成颗粒，能够直接将颗粒喂到挤出机造粒，增加造粒的产量

Used for drying washed plastic(film,bag,woven bag,jumbo bag) scrap and make it to granules.The granules can be put into extruder directly and help to increase the pelletizing production.

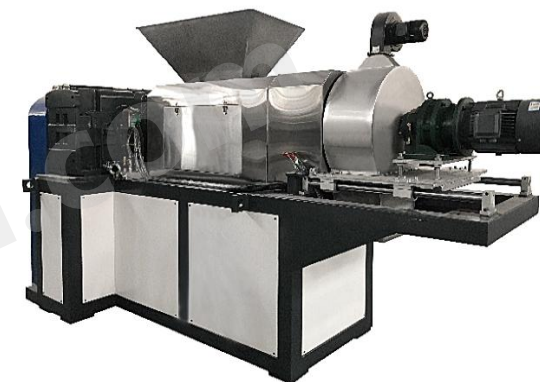

Film squeezing pelletizing machine 挤干造粒机

型号/model	FSP-250	FSP-280	FSP-315	FSP-350	FSP-400
产量/Capacity	250-300kg/hr	350-400kg/hr	400-500kg/hr	600-800kg/hr	800-1000kg/hr
螺杆直径/Screw Diameter	Φ250mm	Φ280mm	Φ315mm	Φ350mm	Φ400mm
主机功率/Main motor power	55/75KW	90KW	110KW	132KW	160KW
加热功率/heating Power	8KW	9KW	11KW	12KW	15KW
切粒刀/cutting blades	4片	4片	4片	4片	4片
出料孔径/Material outlet hole diameter	14mm	14mm	14mm	14mm	14mm
切粒功率/Cutting Power	4KW	5.5KW	5.5KW	7.5KW	7.5KW
风机功率/Blower Power	4KW	5.5KW	5.5KW	7.5KW	7.5KW
含水率/moisture remain	~5%	~5%	~5%	~5%	~5%

Plastic Pulverizer Machine

磨粉机

Rotor Type Pulverizer Machine

转子式磨粉机

通过转子高速旋转和定刀将塑料磨成粉末，主要用于PVC塑料；

Use the high speed rotary rotor with fixed blades to milling the plastic into powder, its mainly used for the PVC material; Its economic and easy maintenance;



型号/Model	SMW-400	SMW-500	SMW-600
磨粉腔/Milling chamber DIA:	Φ400	Φ500	Φ600
动刀/Rotary Blades	20PCS	24PCS	30 PCS
转速/Main Speed RPM.	3800	3900	3900
主机功率/Main motor power:	30KW	37KW	45KW
目数/Final powder size	12-120 micron	12-120 micron	12-120 micron
产量/Capacity	50-120kg/hr	150-200kg/hr	300-500kg/hr
重量/Machine weight	850kgs	1200kgs	1550kgs
外形尺寸/Dimension	2200*800*2100 (mm)	5900*1450*2900 (mm)	5900*1450*2900 (mm)
备注/Remark:			

Disc Type Pulverizer Machine

磨盘式磨粉机

通过动，定磨盘的高速运转将塑料磨成粉末，可以用于PE, PVC,木屑等相对软性的塑料；

It use the fixed disc and rotary disc high speed rolling to milling the plastic, wood chips into powder; Its mainly used for the PE granules, PVC lables, wood chips and so on soft palstic;



型号/model	MF-400	MF-550	MF-650	MF-810
主电机/Main motor	37 KW	45 KW	55 KW	75 KW
产量/Capacity kg/h	120-200	200-300	300-500	500-800
刀片直径/Blade Dia.	Φ450mm	Φ550mm	Φ650mm	Φ800mm
振动喂料/Auto vibrating feeder	0.55 kw	0.75 kw	0.75 kw	1.1 kw
风机/Air blower	3 KW	4 KW	5.5 KW	7.5 KW
振动筛/Vibrator Screen	1.5 kw	1.5 kw	2.2 kw	2.2 kw
目数/Screen Mesh	15-120micron	15-120micron	15-120micron	15-120micron
除尘系统/Dust collecting system	One set	One set	One set	One set
备注/Remark:				

Vertical Baler Machine

立式打包机

主要用于废旧塑料，薄膜，可乐瓶，废纸的打包，液压自动控制；

It used for the waste Plastic, Plastic Film, Plastic Bottle and waste paper baling, working with hydraulic, automatic control;

型号/MODEL	VB-20	VB-30	VB-40	VB-60	VB-80	VB-120	VB-150
压力/Pressing Pressure (Tons)	20	30	40Ton	50Tons	80	120	150
加料口尺寸/Feed Opening Size(mm)	700x400	800x500	1000x500	1100x500	1200x500	1400x600	1800x750
"打包尺寸/LxWxH, H可调(mm)	800x600	800x600	1000x600	1100x700	1200x800	1400x800	1800x1000
Bale size (LxWxH is adjustable)"	x800	x1000	x1000	x1000	x1200	x1200	x1200
油泵功率/Pump Power (KW)	3	5.5	7.5	11	15	18.5	22
包块重量/Bale Wight (kg)	30-100	30-120	60-150	100-200	200-300	300-400	400-600
设备重量/Machine Weight (mm)	1100	1500	1700	2000	2500	5500	7500
设备尺寸LxWxH	1300x800	1280x850	1500x1000	1600x1100	1700x1200	1700x1200	1700x1200
Dimension (L xW xH)	x2800	x3300	x3400	x3500	x3900	x3800	x3800



Horizontal Baler Machine 卧式打包机



PET

Strap Production Line 打包带生产线

www.moogetech.com



PET Strap Production Line PET打包带生产线

本公司研发生产的全自动PET打包带生产线是吸收引进国外先进技术制作而成。采用最新PLC电脑控制系统，用于对熔体温度、压力、挤出速度、扭矩、牵引等实时控制，确保产品质量。

原料为：100% PET瓶片回收料或者PET全新料，也可以回收料和全新料混合使用；

整条生产线包括：上料机、挤出机、三台拉伸机、烘箱、模具、牵引机、控制箱、收卷机以及模温机、冷水机、干燥机辅机。

This production line is used to produce the PET packing band, PET packing strap; Adopt the PLC control the whole line do the Automatic Production. It use the melting pump and pressure sensor ensure the production stable and strap quality control;

The raw material you can use is 100% recycled PET flakes from the waste PET bottles, or virgin material or mixed with each other;

Advantages:

- 1- Use 100% Recycled PET flakes to reduce the cost;
- 2- Good dehumidifier drying system (Crystallization system Optional) to ensure the material equal dry to produce high quality strapping
- 3- Special Design Hot Forming tensile tank to to make good forming, equal width, straight strap;



Line Model:

Model 型号	Capacity (kg/h) 产量	Strap Size 规格尺寸	Installed Power 装机功率	ManPower 人工	Area Required: L*W*H 尺寸: 长*宽*高
SJ65/33 Single Strap	50-60	9-19(mm)	85KW	2	35mx4mx5m
SJ75/33 Single Strap	80-100	9-19(mm)	100KW	2	38mx4mx6m
SJ75/33 Double Strap	80-120	9-19(mm)	110KW	2	40mx4mx6m
SJ90/33 Double Strap	150-200	9-19(mm)	150KW	2	45mx5mx7m
SJ120/33 Triple Strap	200-250	9-19/25(mm)	220KW	2	45mx5mx7m



PP

Strap Production Line

打包带生产线

www.moogetech.com



PP strap Production Line

PP打包带生产线

- 一、PP打包带生产线组成：
PP轻质环保打包带生产线由自动吸料机一套、单螺杆挤出主机一套、不锈钢冷却水槽一套、牵引机组三套、延伸烘箱机组一套、印字机一套、压花机组一套、定形烘箱机组一套、双配置收卷机组一套组成。
- 二、该系列PP打包带生产线具有以下特点：
- (1) 产量高：主机一出二
 - (2) 规格齐全：宽5-19mm，厚0.4-1.3mm，长7000米以下规格的机用、透明、全新料、环保、彩色、印字、等轻质打包带都可以生产；
 - (3) 智能化高：自动吸料，不需再烘料，压花同步、印字清晰；
 - (4) 节能环保：填充料为颗粒料，车间干净、粉尘少，用电量35度左右/小时，冷却水可循环使用；
 - (5) 节省人工：3人2班次24小时生产；
 - (6) 操作快捷：换模5分钟，换网10分钟，从拉带到成品30分钟；
 - (7) 品质稳定：宽窄和厚薄均匀，偏斜度小，广泛适用于全自动、半自动、手动等各种类型打包机；
 - (8) 原料充足：从PP填充料和全新料都能适应。

The PP Strap Production Line composed by: Screw Loader, Extruder, Screen Changer, Die Mold, Water Cooling tank, Haul-Off machine, Stretching Machine, Heating Oven, Ink Printing, embossing unit, Tensile remove forming tank and winder machine

- Advantages:
- 1- Higher automatic operating with higher output
 - 2- Lower power consumption
 - 3- Produce stable quality strap with good straightness, equal width and thickness control
 - 4- Can use recycled plastic or PP virgin material

SJ65/33 PP Single Strap Production Line

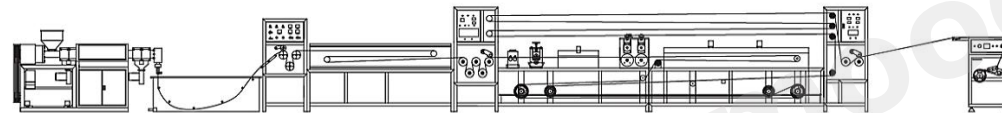

SJ65/33 PP Double Strap Production Line

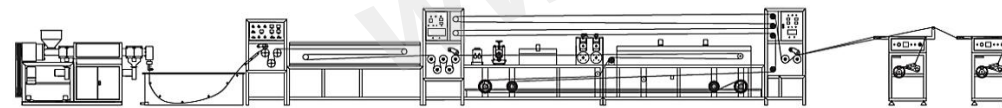

SJ85/33 PP Double Strap Production Line

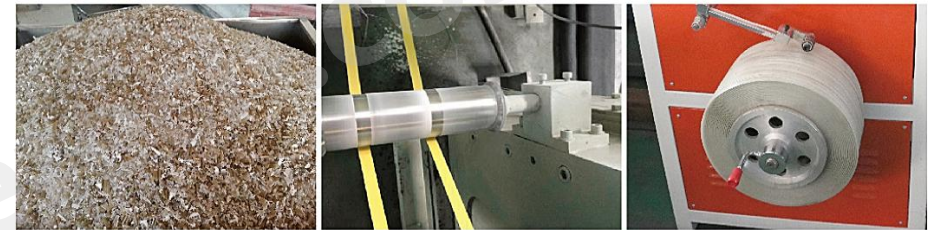
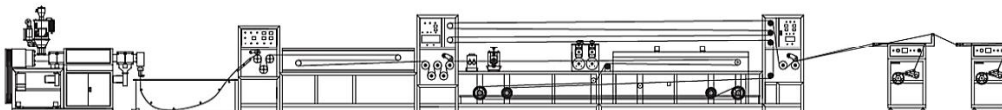

Line Model:

Model 型号	Capacity 产量(kg/h)	Strap Size 规格尺寸	Installed Power 装机功率	ManPower 人工	Area Required: L*W*H 尺寸: 长*宽*高
SJ65/33 Single Strap	30-40	5-19(mm)	45KW	1-2	25m*4m*4m
SJ85/33 Double strap	60-80	5-19(mm)	65KW	1-2	30m*4m*5m



T Series-For Film, Raffia/Woven Bags, Jumbo Bags Plastic Crusher 系列破碎机

本设备主要用于破碎废旧塑料薄膜、编织袋、吨包袋、塑料瓶、桶等各种塑料容器
It used to crushing the waste Plastic Film, woven bags, Raffia bags, Jumbo bags, plastic bottles, barrels, buckets etc.



S Series-For PET/PE/PP Bottles, ABS/PS Plastic Plastic Crusher 破碎机

本设备主要用于破碎废旧塑料瓶、桶等各种塑料容器，特殊设计刀架结构，具有更高的效能比
Used for the PET bottle, Plastic Bottle, buckets, hollow containers, and so on plastic; Its with special structure design, will have more capacity with less power consumption



T Series-For Film Plastic Crusher T系列破碎机

型号/Model	T-600	T-800	T-1000	T-1200
动刀数量/Rotor blade	6	6	6	6
定刀数量/Fixed blade	4	4	4	4
转速/RPM	500	500	500	500
筛网尺寸/Screen (For Film)	50mm	50mm	50mm	50mm
电机功率/Power	30	37/45	45/55	55/75
产量/Capacity (Film)	200kg/hr	300kg/hr	500kg/hr	800-1000kg/hr

S Series-For Bottles Plastic Crusher S系列破碎机

产品型号/Model	S-600	S-800	S-1000	S-1200	S-1500
动刀数量/Rotor blade	8	8	8	12	12
定刀数量/Fixed blade	4	4	4	4	6
筛网尺寸/Screen	14/16mm	14/16mm	14/16mm	14/16mm	14/16mm
电机功率/Power	30	37/45	45/55	55/75	75/90
产量/Capacity (Pressed Bottles)	300kg/hr	500kg/hr	800-1000kg/hr	1000-1500kg/hr	1500-2000kg/hr

Waste water treatment

Plastic recycling washing line dedicated sewage

塑料回收清洗线专用污水处理系统

www.moogetech.com

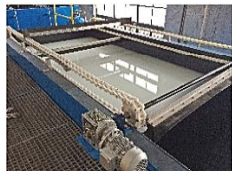
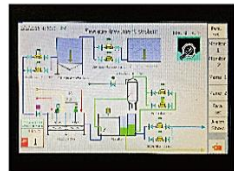
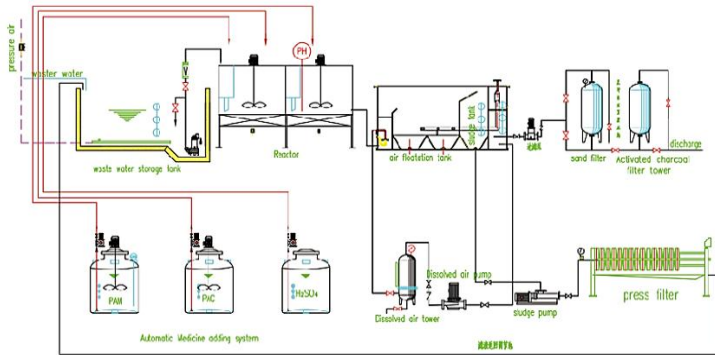

CE GPC ISO 9001:2000 SGS

PC Series

Plastic Crusher

PC塑料破碎机

本设备主要用于破碎废旧HDPE/PP 塑料瓶, 桶等各种塑料容器;
Used for the HDPE/PP Bottles, barrels, buckets, hollow container and so on plastic;

- | | |
|-----------|--|
| 加大转子直径 | Big Rotor |
| 重型皮带轮 | Big Heavy Pulley |
| 水冷轴承座 | Water Cooling Bearing House |
| 双层隔音箱体 | Double Layout Hopper insulation |
| 后置式定刀便于拆换 | Rear back Fixed Bladed Easier Changing |

Silent Model



Standard Model



PC Series Plastic Crusher

PC塑料破碎机

型号/Model	PC-500	PC-600	PC-800	PC-900	PC-1000
动刀数量/Rotor blade	15	9 or 18	12 or 24	15 or 27	12 or 15 or 30
定刀数量/Fixed blade	2	2	4	4	4
转速/RPM	580	580	580	580	580
筛网尺寸/Screen	18mm	18mm	18mm	18mm	18mm
电机功率/Power	11KW	15KW	22KW	30KW	37KW
产量/Capacity	200kg/hr	300kg/hr	500-800kg/hr	800-1000kg/hr	1000-1500kg/hr
重量/Weight (kgs)	1500kgs	2000kgs	2500kgs	3000kgs	3500kgs



VS Series

Single Shaft Shredder Machine 普通单轴撕碎机

本设备主要用于撕碎机头料，大块料，PE，PVC厚壁管，波纹管以及其他破碎机难以处理的废料
Used for the die material, big block material, PE, PVC thick wall pipe and other plastic material which is difficult processed by the crusher machine



VS Series Single Shaft Shredder Machine VS系列普通单轴撕碎机

型号/Model	VS-2860	VS-4080	VS-40100	VS-40120	VS-40150	VS-48150
电机功率/Motor Power	22KW	37KW	45KW	55KW	75KW	90KW
主轴转速/Rotor Speed	83RPM	83RPM	83RPM	83RPM	83RPM	83RPM
转子直径/Rotor Diameter	Φ280	Φ400	Φ400	Φ400	Φ400	Φ480
动刀数量/Rotor Blades QTY	26	38	46	58	74	111
定刀数量/Fixed Blades QTY	1	2	2	2	3	3
筛网直径/Screen Dia.	60mm	60mm	60mm	60mm	60mm	60mm
产量/Capacity	300kg/hr	600kg/hr	800kg/hr	1000kg/hr	1500kg/hr	2000kg/hr
外形尺寸/Diension (mm)	2225x1350	3000x1680	3000x1880	3000x2200	3300x2500	3300x2600
	x1885	x2150	x2150	x2450	x2500	x2500
重量/Weight	1850kgs	3000kgs	3800kgs	4200kgs	5500kgs	6500kgs



VSG Series

Single Shaft Shredder Machine 管材专用单轴撕碎机

本设备主要用于大口径且长度较长的PE，PVC厚壁管，波纹管以及其他破碎机难以破碎的管材
Used for the large and long PE, PVC thick wall pipe and other plastic pipe which is difficult processed by the crusher machine



VSG Series Single Shaft Shredder Machine VSG系列管材专用单轴撕碎机

型号/Model	VSG-2860	VSG-4080	VSG-40100	VSG-40120
电机功率/Motor Power	22KW	37KW	45KW	55KW
主轴转速/Rotor Speed	83RPM	83RPM	83RPM	83RPM
转子直径/Rotor Diameter	Φ280	Φ400	Φ400	Φ400
动刀数量/Rotor Blades QTY	26	38	46	58
定刀数量/Fixed Blades QTY	1	2	2	2
筛网直径/Screen Dia.	60mm	60mm	60mm	60mm
产量/Capacity	300kg/hr	500kg/hr	600kg/hr	800kg/hr
外形尺寸/Diension	2525x1350x1885mm	3300x1680x2150mm	3300x1880x2150mm	3300x2200x2450mm
重量/Weight	2350kgs	3500kgs	4300kgs	4800kgs

VSP Series Single Shaft Shredder Machine 撕碎破碎一体机

本设备主要用于撕碎破碎机头料，大块料，PE, PVC厚壁管，波纹管以及其他破碎机难以处理的废料，并且能够生产客户所需尺寸的颗粒
Used for the die material, big block material, PE, PVC thick wall pipe and other plastic material which is difficult processed by the crusher machine, and it can produce the plastic flakes as customer's request



VSP Series Single Shaft Shredder Machine
VSP系列撕碎破碎一体机

型号/Model	VSP-2860	VSP-4080	VSP-40100	VSP-40120
撕碎机电机功率/Shredder Motor Power	22KW	37KW	45KW	55KW
撕碎机主轴转速/Shredder Rotor Speed	83RPM	83RPM	83RPM	83RPM
撕碎机转子直径/Shredder Rotor Diameter	Φ280	Φ400	Φ400	Φ400
撕碎机动刀数量/Shredder Rotor Blades QTY	26	38	46	58
撕碎机定刀数量/Shredder Fixed Blades QTY	1	2	2	2
撕碎机筛网直径/Shredder Screen Dia.	60mm	60mm	60mm	60mm
破碎机功率/Crusher Motor Power	15KW	22KW	30KW	30KW
破碎机动刀数量/Crusher Rotor Blades QTY	18	24	30	30
破碎机定刀数量/Crusher Fixed Blades QTY	2	4	4	4
破碎机筛网直径/Crusher Screen Dia.	12mm	12mm	12mm	12mm
产量/Capacity	300kg/hr	500kg/hr	800kg/hr	1000kg/hr



VSD Series Double Single Shaft Shredder Machine 双单轴撕碎机

本设备主要用于撕碎松散薄膜，编织袋等不同软料
Used for the loosen soft plastic such as the PE/PP Film, PP Woven or Non-woven bag, Jumbo bags etc



VSD Series Double Single Shaft Shredder Machine
VSD系列双单轴撕碎机

型号/Model	VSD-4060	VSD-4080	VSD-40100	VSD-40120
电机功率/Motor Power	30KW+30KW	37KW+37KW	37KW+37KW	45KW+45KW
主轴转速/Rotor Speed	83RPM	83RPM	83RPM	83RPM
转子直径/Rotor Diameter	Φ400	Φ400	Φ400	Φ400
动刀数量/Rotor Blades QTY	72	96	120	144
定刀数量/Fixed Blades QTY	2	4	4	4
产量/Capacity	300kg/hr	600kg/hr	1000kg/hr	1500kg/hr
外形尺寸/Dimension	3000x1350x2400mm	3200x1350x2450mm	3500x1350x2500mm	3900x1350x2500mm
重量/Weight	3800kgs	4500kgs	5500kgs	7000kgs

VH Series

Single Shaft Shredder Machine

摆臂式单轴撕碎机

本设备主要用于撕碎薄膜包，编织袋包等软料包，废旧塑料瓶，桶等各种塑料容器
Used for the baled soft plastic such as PP/PE film bale, PP woven or Non-woven bags bale, Jumbo bags bale, plastic bottle, buckets, hollow containers and so on plastic



VH Series Single Shaft Shredder Machine

VH系列摆臂式单轴撕碎机

型号/Model	VH-4880	VH-48100	VH-48120	VH-48150	VH-48200	VH-65 Series
电机功率/Motor Power	45KW	55KW	75KW	75KW+75KW	75KW+75KW	-
主轴转速/Rotor Speed	83RPM	83RPM	83RPM	83RPM	83RPM	83RPM
转子直径/Rotor Diameter	Φ480	Φ480	Φ480	Φ480	Φ480	Φ650
动刀数量/Rotor Blades QTY	38	46	58	111	135	-
定刀数量/Fixed Blades QTY	2	2	2	3	4	-
产量/Capacity	500kg/hr	800kg/hr	1000kg/hr	1500kg/hr	2000kg/hr	-
外形尺寸/Diimension	2250x1850 x2530mm	2550x1850 x2530mm	2850x1850 x2530mm	3300x2650 x2750mm	4030x2650 x2750mm	-
重量/Weight	4500kgs	5500kgs	6200kgs	8500kgs	10500kgs	-



VD Series

Double Shaft Shredder Machine

双轴撕碎机

本设备主要用于撕碎薄壁桶料，薄壁瓶，吹塑制品等塑料，以及一些城市垃圾废料处理
Used for the thin thickness wall plastic such as the bucket, barrels, crates, pallets, basin, blow molding products and some heavy duty city waste



VD Series Double Shaft Shredder Machine

VD系列双轴撕碎机

型号/Model	VD-3040	VD-3060	VD-3080	VD-30100	VD-3580	VD-35100	VD-35120
电机功率/Motor Power (KW)	7.5	5.5+5.5	11+11	15+15	11+11	18.5+18.5	22+22
主轴转速/Rotor Speed (RPM)	15	15	15	15	15	15	15
转子直径/Rotor Diameter	Φ300	Φ300	Φ300	Φ300	Φ350	Φ350	Φ350
刀片厚度/Blade Thickness (mm)	20	20	20	20	25	25	25
动刀数量/Fixed Blades QTY	20	30	40	50	32	40	48
重量/Weight (kgs)	1500	2200	2500	2800	3200	4000	4800

型号/Model	VD-35150	VD-4380	VD-43100	VD-43120	VD-52100	VD-52130	VD-52160
电机功率/Motor Power (KW)	30+30	22+22	22+22	30+30	37+37	45+45	55+55
主轴转速/Rotor Speed (RPM)	15	15	15	15	15	15	11
转子直径/Rotor Diameter	Φ350	Φ430	Φ430	Φ430	Φ520	Φ520	Φ520
刀片厚度/Blade Thickness (mm)	25	40	40	40	40	40	50
动刀数量/Fixed Blades QTY	60	20	25	30	25	32	32
重量/Weight (kgs)	5500	4600	5400	7000	10500	12000	14000



VF Series

Four-Shaft Shredder Machine

四轴撕碎机

四轴撕碎机适合撕碎：塑料桶、塑料瓶、金属罐、油漆金属桶、轮胎、汽车保险杠、电路板等物料，出料大小可控制、效率高、低转速、大扭矩、低噪音，同时本机采用微电脑（PLC）自动控制，设启动、停止、反转及超载自动反转控制功能。

The Four-Shaft Shredder Machine is good at shredding the big plastic barrel, tanks, bottles, steel barrels, paint tanks, tyres and car parts, TV, fridges, computers and others etc. Its automatic controlled by the PLC.

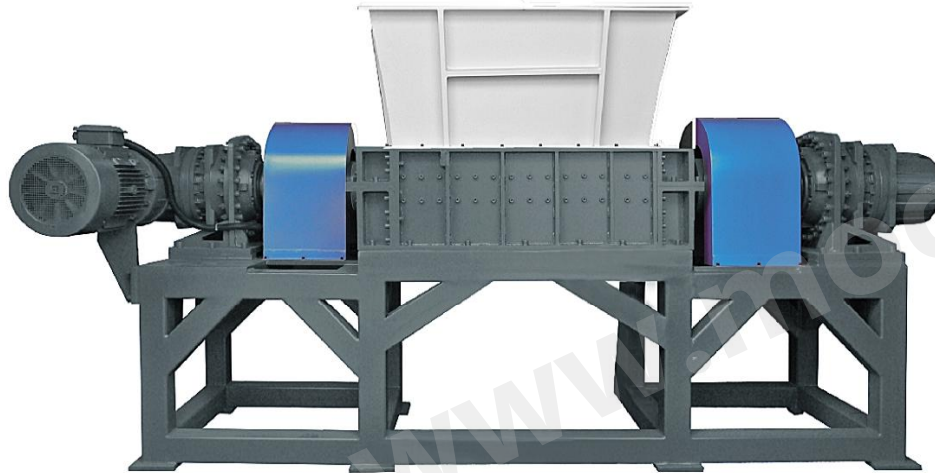

VF Series Four-Shaft Shredder Machine

VF系列四轴撕碎机

型号/Model	VF-3060	VF-3080	VF-35100	VF-35120	VF-43160
电机功率/Motor Power (KW)	15+15	18.5+18.5	22+22	30+30	45+45
主轴转速/Rotor Speed (RPM)	15	15	15	15	11
转子直径/Rotor Diameter	Φ300	Φ300	Φ350	Φ350	Φ430
刀片厚度/Blade Thickness (mm)	25	25	25	25	40
动刀数量/Fixed Blades QTY	48	64	80	96	80
重量/Weight (kgs)	3500	5000	6500	8500	11000



VDT Series

Double Shaft Shredder Machine with Trommel

带滚筒筛双轴撕碎机

本设备主要用于撕碎薄壁桶料，薄壁瓶，吹塑制品等塑料，以及轮胎和一些城市垃圾废料处理，并且能够生产客户所需尺寸的颗粒

Used for the thin thickness wall plastic such as the bucket, barrels, crates, pallets, basin, blow molding products, tyre and some heavy duty city waste, and it can produce the flakes as customer's request



VDT Series Double Shaft Shredder Machine with Trommel

VDT系列带滚筒筛双轴撕碎机

型号/Model	VDT-30100	VDT-30120	VDT-3580	VDT-35100	VDT-35120
电机功率/Motor Power (KW)	15+15	18.5+18.5	11+11	18.5+18.5	22+22
主轴转速/Rotor Speed (RPM)	15	15	15	15	15
转子直径/Rotor Diameter	Φ300	Φ300	Φ350	Φ350	Φ350
刀片厚度/Blade Thickness (mm)	20	20	25	25	25
动刀数量/Fixed Blades QTY	50	60	32	40	48
重量/Weight (kgs)	4300	4000	3800	4600	5600

型号/Model	VDT-35150	VDT-4380	VDT-43100	VDT-43120
电机功率/Motor Power (KW)	30+30	15+15	22+22	22+22
主轴转速/Rotor Speed (RPM)	15	15	15	15
转子直径/Rotor Diameter	Φ350	Φ430	Φ430	Φ430
刀片厚度/Blade Thickness (mm)	25	40	40	40
动刀数量/Fixed Blades QTY	60	20	25	30
重量/Weight (kgs)	6500	5200	6800	8200